

**Mitteldruckventilatoren GR und GT
Hochdruckventilatoren HR**

**Accessories medium pressure fans GR and GT
Accessories high pressure fans HR**

Saugstutzen

intake connector for tube connection

Ventilator-Größe Fan-Size	Nennweite Ventilator- seite NW V	Lichte Weite Kunden- seite LW K	Nennweite Kunden- seite NW K	Dietz Artikel- nummer	DP [mm]	DA [mm]	s [mm]	l ca. [mm]	sb ca. [mm]
G./H. 063	71	70	80	223475	110	138	9,5 (4x90°)	60	8
	71	60	70	223476	110	138	9,5 (4x90°)		
G./H. 071	80	80	90	223477	118	138	9,5 (4x90°)	60	8
	80	70	80	223478	118	138	9,5 (4x90°)	60	8
G./H. 080	90	90	100	223479	128	158	9,5 (4x90°)	60	8
	90	80	90	223480	128	158	9,5 (4x90°)	60	8
G./H. 090	100	100	110	223481	139	158	9,5 (4x90°)	60	8
	100	90	100	223482	139	158	9,5 (4x90°)	60	8
G./H. 100	112	115	125	223483	151	185	9,5 (4x90°)	60	8
	112	100	110	223484	151	185	9,5 (4x90°)	60	8
G./H. 112	125	130	140	223485	165	185	9,5 (4x90°)	60	8
	125	115	125	223486	165	185	9,5 (4x90°)	60	8
G./H. 125	140	140	150	223487	182	224	11,5 (8x45°)	60	8
	140	130	140	223488	182	224	11,5 (8x45°)	60	8
G./H. 140	160	160	170	223489	200	224	11,5 (8x45°)	60	8
	160	140	150	223490	200	224	11,5 (8x45°)	60	8
G./H. 160	180	180	190	223491	219	265	11,5 (8x45°)	60	8
	180	160	170	223492	219	265	11,5 (8x45°)	60	8
G./H. 180	200	180	190	223493	241	265	11,5 (8x45°)	60	8

Druckstutzen

**outlet connector
for tube connection**

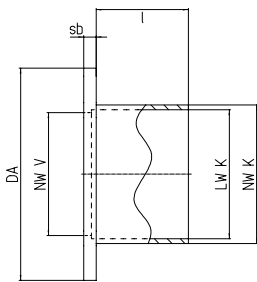
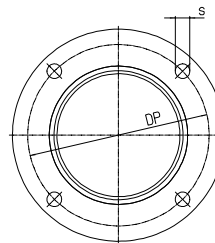

Ventilator-Größe Fan-Size	Nennweite Ventilator- seite NW V	Lichte Weite Kunden- seite LW K	Nennweite Kunden- seite NW K	Dietz Artikel- nummer	DP [mm]	DA [mm]	s [mm]	l ca. [mm]	sb ca. [mm]
G./H. 063	63	60	70	223474	100	138	9,5 (4x90°)	60	8
G./H. 071	71	70	80	223475	110	138	9,5 (4x90°)	60	8
	71	60	70	223476	110	138	9,5 (4x90°)	60	8
G./H. 080	80	80	90	223477	118	138	9,5 (4x90°)	60	8
	80	70	80	223478	118	138	9,5 (4x90°)	60	8
G./H. 090	90	90	100	223479	128	159	9,5 (4x90°)	60	8
	90	80	90	223480	128	159	9,5 (4x90°)	60	8
G./H. 100	100	100	110	223481	139	159	9,5 (4x90°)	60	8
	100	90	100	223482	139	159	9,5 (4x90°)	60	8
G./H. 112	112	115	125	223483	151	185	9,5 (4x90°)	60	8
	112	100	110	223484	151	185	9,5 (4x90°)	60	8
G./H. 125	125	130	140	223485	165	185	9,5 (4x90°)	60	8
	125	115	125	223486	165	185	9,5 (4x90°)	60	8
G./H. 140	140	140	150	223487	182	224	11,5 (8x45°)	60	8
	140	130	140	223488	182	224	11,5 (8x45°)	60	8
G./H. 160	169	160	170	223489	200	224	11,5 (8x45°)	60	8
	160	140	150	223490	200	224	11,5 (8x45°)	60	8
G./H. 180	180	180	190	223491	219	265	11,5 (8x45°)	60	8
	180	160	170	223492	219	265	11,5 (8x45°)	60	8

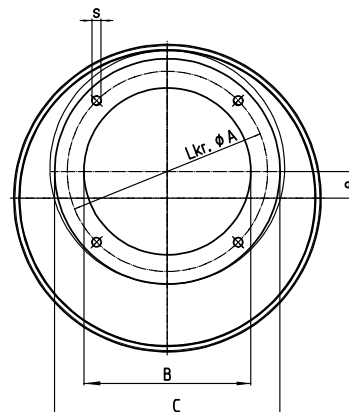
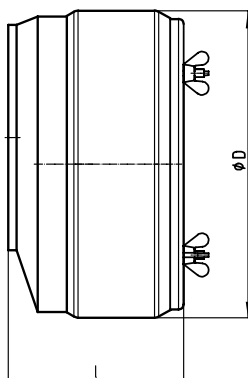
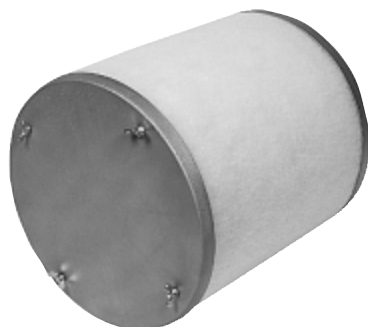
Rundfilter
cylindrical intake filter

Typ Ventilator-Größe Fan-Size	A	B	C	Ø D	l	s	e	Dietz- Artikel- Nummer	Zwischen- ring	Ersatzfiltermatte (fein) Art.-Nr. spare filter mat	L x b [mm]
HR 063-...	120	100	135	184	105	5,5	16	192242		192251	543 x 85
HR 071-...	120	100	135	184	145	5,5	16	192293		192296	543 x 85
HR 080-...	120	100	135	184	200	5,5	16	192363		192366	543 x 85
HR 090-...	146	125	168	231	230	5,5	20	192473		192484	688 x 200
HR 100-...	148	125	168	231	300	5,5	20	192526		192532	688 x 270
HR 112-...	165	150	185	277	340	5,5	24	192617		192627	840 x 295
HR 125-...	198	184	220	335	490	6,5	28	192861		192873	1015 x 425
HR 140-...	226	205	250	387	800	6,5	35	193000		193002	1178 x 735
HR 160-...	286	270	315	447	690	6,5	45	193133	207203	193135	1366 x 615
HR 180 -...	Ohne Filter/ No filter										

Filtermaterial:

Filterklasse G3 DIN EN 779
 Polyester-Wirrvlies 240 g/m² DIN EN 12127
 100% feuchtbeständig
 max. Temperatur 100 °C

Filter material:

Filter class G3 DIN EN 779
 Polyester fleece 240 g/m² DIN EN 12127
 100% wet resistant
 max. temperature 100 °C

Schutzgitter Saugseite
wire mesh guard intake

Typ Ventilator-Größe Fan-Size	Dietz- Artikel- Nummer	Lkr. [mm]
HR 063	221926	110
HR 071	221929	118
HR 080	221930	128
HR 090	221931	139
HR 100	221983	151
HR 112	221984	165
HR 125	221985	182
HR 140	221986	200
HR 160	221987	219
HR 180	221988	241

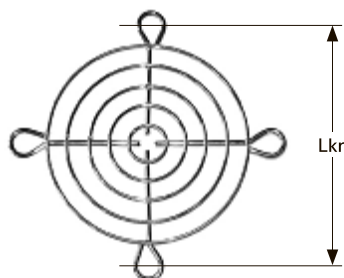

Rohrschalldämpfer

Tube silencer

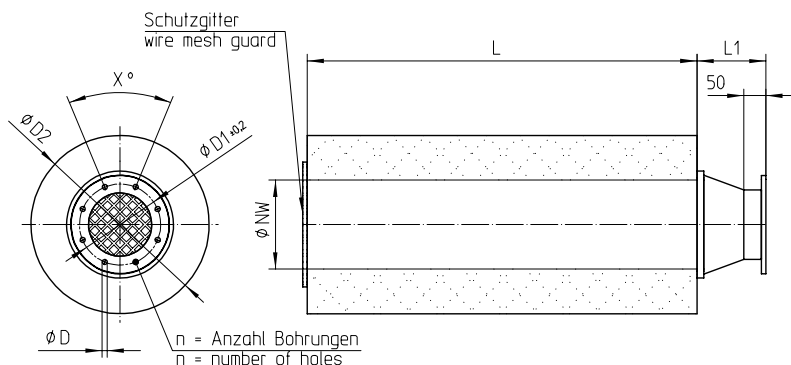

Schalldämpfer Saugseite

Silencer suction side

Ventilator Fan	D1 [mm]	D [mm]	n	X°	D2 [mm]	NW [mm]	L [mm]	L + L1 [mm]	Einfügungsdämpfungsmaß D _e in dB Insertion loss D _e in dB		Artikelnr. Partnumber
									125 Hz	250 Hz	
GR / HR 063	110	4 x 9,5	4	90	300	125	975	1145	10,5	21,0	252209
GR / HR 071	118	4 x 9,5	4	90	300	125	975	1135	10,5	21,0	252210
GR / HR 080	128	4 x 9,5	4	90	300	125	975	1120	10,5	21,0	252211
GR / HR 090	139	4 x 9,5	4	90	355	160	975	1150	9,5	18,5	252212
GR / HR 100	151	4 x 9,5	4	90	355	160	975	1135	9,5	18,5	252213
GR / HR 112	165	4 x 9,5	4	90	400	200	975	1175	8,0	15,5	252214
GR / HR 125	182	8 x 11,5	8	45	400	200	975	1150	8,0	15,5	252215
GR / HR 140	200	8 x 11,5	8	45	500	250	975	1195	10,5	17,5	252216
GR / HR 160	219	8 x 11,5	8	45	630	355	1475	1810	11,5	19,0	252217
GR / HR 180	241	8 x 11,5	8	45	630	355	1475	1785	11,5	19,0	252218

Schalldämpfer Druckseite

Silencer pressure side

Ventilator Fan	D1 [mm]	D [mm]	n	X°	D2 [mm]	NW [mm]	L [mm]	L + L1 [mm]	Einfügungsdämpfungsmaß D _e in dB Insertion loss D _e in dB		Artikelnr. Partnumber
									125 Hz	250 Hz	
GR / HR 071	110	4 x 9,5	4	90	300	125	975	1145	10,5	21,0	252209
GR / HR 080	118	4 x 9,5	4	90	300	125	975	1135	10,5	21,0	252210
GR / HR 090	128	4 x 9,5	4	90	300	125	975	1120	10,5	21,0	252211
GR / HR 100	139	4 x 9,5	4	90	355	160	975	1150	9,5	18,5	252212
GR / HR 112	151	4 x 9,5	4	90	355	160	975	1135	9,5	18,5	252213
GR / HR 125	165	4 x 9,5	4	90	400	200	975	1175	8,0	15,5	252214
GR / HR 140	182	8 x 11,5	8	45	400	200	975	1150	8,0	15,5	252215
GR / HR 160	200	8 x 11,5	8	45	500	250	975	1195	10,5	17,5	252216
GR / HR 180	219	8 x 11,5	8	45	630	355	1475	1810	11,5	19,0	252217

Schalldämpfer zur Förderung von normaler Umgebungsluft.
 Maximal zulässige Fördermedientemperatur: +100°C.
 Ventilatoranschluß mit Flansch DIN 24154 R2.
 Ansaug- bzw. Ausblasseite mit Schutzgitter.
 Außenmantel aus bandverzinktem Wickelfalzrohr.
 Absorptionsmaterial aus biolöslicher Mineralwolle,
 unbrennbar nach DIN 4102, Klasse A.
 Der Schalldämpfer kann nur an der freien Ansaug- bzw.
 Ausblasseite eingesetzt werden.
 Die Montage muß spannungsfrei erfolgen.
 Zusatzlasten müssen bauseits separat abgefangen werden.

Silencer for conveying of normal ambient air.
 Maximum admissible fluid temperature: +100 ° C.
 Fan connector with flange DIN 24154 R2.
 Exhaust side with wire mesh guard.
 Outer sheath galvanized folded spiral seam pipe.
 Absorption material bio-soluble mineral wool,
 fire-proof according to DIN 4102, Class A.
 The silencer can be used only at the free intake or
 pressure side.
 The installation must be free of tension.
 Additional loads must be intercepted by client separately.