



Niederdruck-Radialventilator



motoren

Low pressure fan

DN 14 (WN 14)

IE3 / IE4

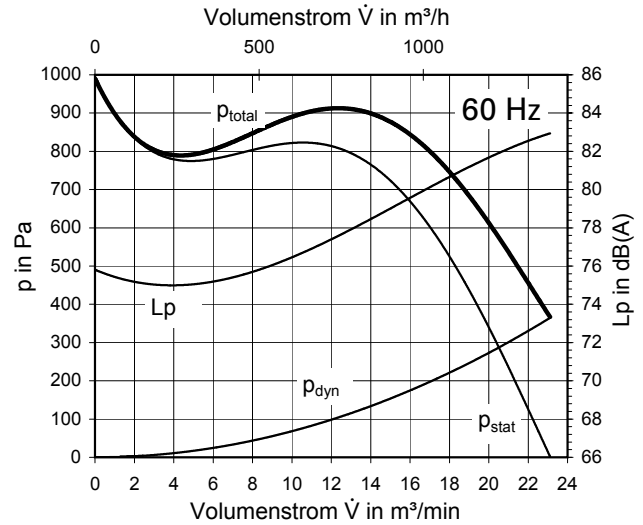
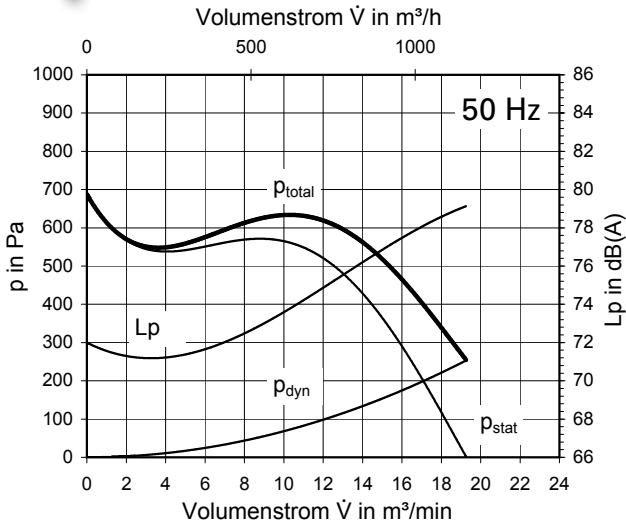

Technische Daten

50 Hz

60 Hz

Technical Data

Typ	DN 14	DN 14	Type
Ventilator rechts ohne Fuß	IE3 259918 IE4 260006	259918 260006	fan right without foot
Ventilator rechts ohne Fuß, jedoch mit Temperatursperre	IE3 259937 IE4 260040	259937 260040	fan right without foot, however with temperature barrier
Volumenstrom, frei ausblasend	19,0 m^3/min (1140 m^3/h)	22,0 m^3/min (2820 m^3/h)	Free outlet flow rate
Druckerhöhung, voll gedrosselt	700 Pa	1000 Pa	Pressure increase, fully throttled
Motor-Bemessungsleistung	0,45 kW	0,75 kW	Motor nominal rating
Gewicht ca.	12,0 kg	12,0 kg	Weight approx.
Ventilatorgehäusematerial	Aluminium	Aluminium	Fan housing material
Laufmaterial	verzinktes Stahlblech/sheet metal zined		Material of impeller
Temperatur des Fördermediums	max. 80 °C (176 °F)	max. 80 °C (176 °F)	Temperature of medium
Ausführung mit Temperatursperre	max. 230 °C (446 °F)	max. 230 °C (446 °F)	with temperature barrier
Spannung Δ	3AC, 220-240 V, 50 Hz	3AC, 254-277 V, 60 Hz	Voltage delta connection
Spannung Y	3AC, 380-420 V, 50 Hz	3AC, 440-480 V, 60 Hz	Voltage star connection
Stromaufnahme max.	IE3 2,10 A, 50 Hz IE4 2,10 A, 50 Hz	2,60 A, 60 Hz 2,50 A, 60 Hz	Current draw. approx.
Typ	WN 14	WN 14	Type
Spannung Kondensator	1AC, 220-240 V, 50 Hz; 30 μF	1AC, 220-240 V, 60 Hz; 50 μF	Voltage capacitor

Die Ventilatoren erfüllen die Wirkungsgradanforderungen der ab 01.01.2015 gültigen ErP-Richtlinie, gemäß Verordnung EU Nr. 327/2011. Technische Daten siehe Inhaltsverzeichnis. The fans meet the efficiency requirements valid from 01.01.2015 ErP Directive, in accordance with EU Regulation No. 327/2011. Technical data, see content.

Abmessungen/Dimensions

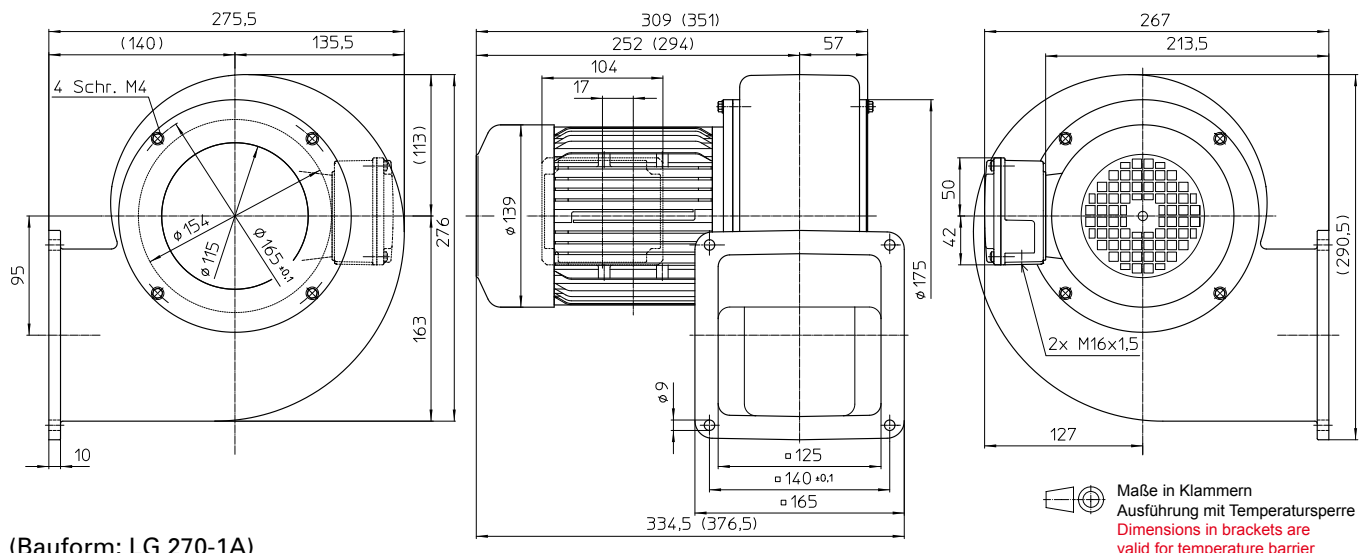

(Bauform: LG 270-1A)